

MAX-S2

last update 28/09/2015

BEL1176

Max-S2 : code 302.GU.___ max. 2x50W QPAR16/GU10 - 230V~ - CE - IP65 - IK04 -  -  0,5 - 

BEL LIGHTING

BEL LIGHTING sprl
Avenue Ernest Solvay 42
B-1480 Saintes (Tubize)
Belgium
Phone: +32(0)2 3552428
Fax: +32(0)2 3550396
e-mail: info@bel-lighting.com
www.bel-lighting.com

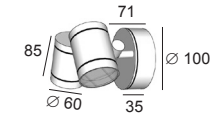

INSTALLATION INSTRUCTIONS - PART A

1. FIT THE WALL FIXATION ON THE WALL
2. MAKE THE ELECTRICAL CONNECTION
3. PLACE THE LUMINAIRE
4. SWITCH ON

1 DIMENSIONS HOLES

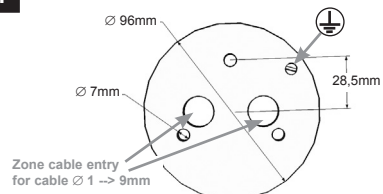

IMPORTANT : Gland for cable Ø 1 ----> 9mm

2 ELECTRICAL CONNECTION

- NL - Voeg de voedingskabel in de beschermingskoker (A)
FR - Insérer le câble d'alimentation dans la gaine de protection(A).
EN - Insert the feeder in the protection sheath (A)
DE - Das Kabel in die Schutzhülle einfügen (A)
EL - Παρεμβάλετε τον τροφοδοτή στη θήκη προστασίας(A)



on 230V

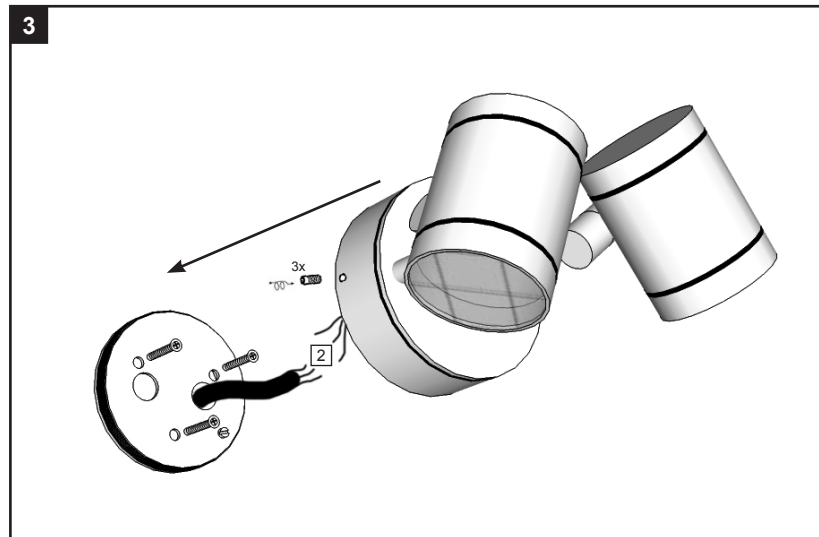
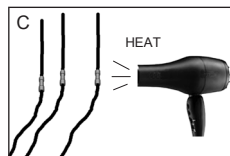
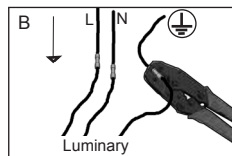
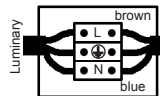

ACCESSORY SET (B)

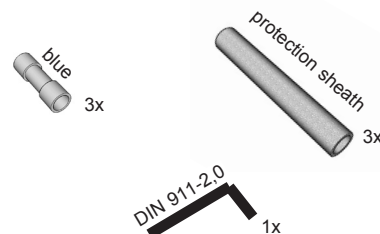

belpasta 1g

- NL Voor een correcte installatie is het verplicht de schroeven te behandelen met belpasta.
FR Pour une bonne installation, vous devez enduire les parties à visser avec la graisse belpasta ci-jointe.
EN For a good installation, it is obliged to put the grease belpasta on the screwing part .
DE Sie müssen die Teile der Leuchte, die geschraubt werden mit dem beigegefügten Fett belpasta bestreichen.
GR Για καλή εγκατάσταση, σας συνιστούμε να βάλετε στα σημεία προς βιδώμα λίγο γρασο belpasta, το οποίο βρίσκεται στην συσκευασία.

PART

A

Lees de algemene gebruiksvoorwaarden : PART B
Lire attentivement les conditions générales d'utilisation: PART B
Read attentively the general instructions: PART B
Lesen Sie die allgemeinen Gebrauchsanweisungen: PART B
Διαβάστε της γενικές οδηγίες : PART B

WAARSCHUWING
AVERTISSEMENT
WARNING
WARNUNG
ΠΡΟΣΟΧΗ