





# Squadra TR

last update 24/09/2015

BEL1144

**Squadra TR :** code 8039.1G9.\_\_\_ H-PIN G9 max. 40W - 230V - CE - IP65 - IK02 -  -  - 

**Squadra TR :** code 8039.W80.\_\_\_ Power Led 6W - 230V - CE - IP65 - IK02 -  -  - 

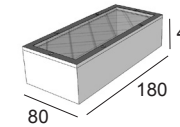

## INSTALLATION INSTRUCTIONS - PART A

1. FIT THE FIXATION ON THE WALL OR ON THE CEILING
2. MAKE THE ELECTRICAL CONNECTION
3. PLACE THE LUMINARY
4. SWITCH ON

### 1 DIMENSIONS HOLES

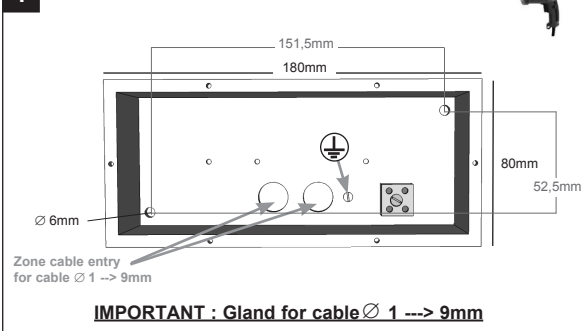

### 3 PLACE THE LUMINARY

G9

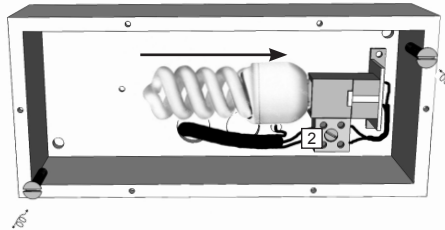

LED

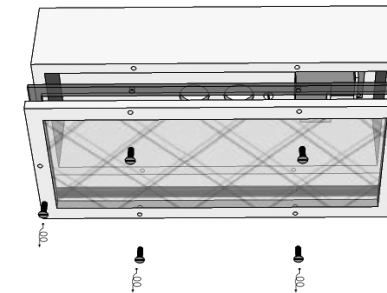
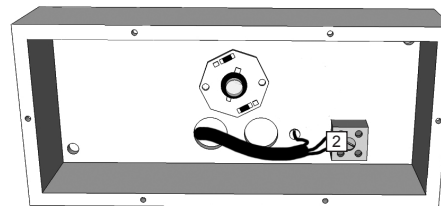

### 2 ELECTRICAL CONNECTION

- NL - Voeg de voedingskabel in de beschermingskoker (A)  
 FR - Insérer le câble d'alimentation dans la gaine de protection(A).  
 EN - Insert the feeder in the protection sheath (A)  
 DE - Das Kabel in die Schutzhülle einfügen (A)  
 EL - Παρεμβάλετε τον τροφοδοτή στη θηκη προστασίας(A)

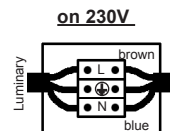

### ACCESSORY SET

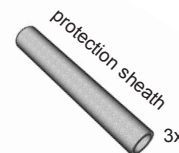

### belpasta 1g

- NL Voor een correcte installatie is het verplicht de schroeven te behandelen met belpasta.  
 FR Pour une bonne installation, vous devez enduire les parties à visser avec la graisse belpasta ci-jointe.  
 EN For a good installation, it is obliged to put the grease belpasta on the screwing part .  
 DE Sie müssen die Teile der Leuchte, die geschraubt werden mit dem beigefügten Fett belpasta bestreichen.  
 GR Για καλή εγκατάσταση, σας συνιστούμε να βάλετε στα σημεία προς βιδώμα λίγο γρασο belpasta, το οποίο βρίσκεται στην συσκευασία.

## PART

# A

Lees de algemene gebruiksvoorwaarden : PART B  
 Lire attentivement les conditions générales d'utilisation: PART B  
 Read attentively the general instructions: PART B  
 Lesen Sie die allgemeinen Gebrauchsanweisungen: PART B  
 Διαβάστε της γενικές οδηγίες : PART B

WAARSCHUWING  
 AVERTISSEMENT  
 WARNING  
 ΠΡΟΣΟΧΗ