



# Visio FL

last update 28/09/2015

BEL1090

Visio FL : code 8007. 2 \_ \_ \_ . \_ \_ \_ 4,8W - 230V~ - CE - IP65 - IK06 -  -  0,5 

  
BEL LIGHTING

BEL LIGHTING sprl  
Avenue Ernest Solvay 42  
B-1480 Saintes (Tubize)  
Belgium  
Phone: +32(0)2 3552428  
Fax: +32(0)2 3550396  
e-mail: info@bel-lighting.com  
www.bel-lighting.com

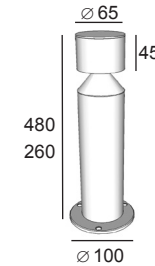

## INSTALLATION INSTRUCTIONS - PART A

1. FIT THE GROUND FIXATION ON THE GROUND
2. MAKE THE ELECTRICAL CONNECTION
3. PLACE THE LUMINARY
4. SWITCH ON

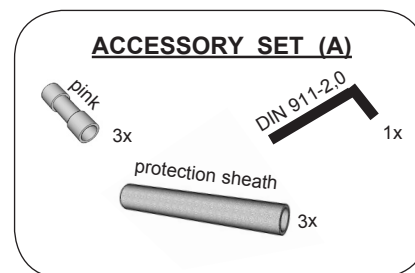
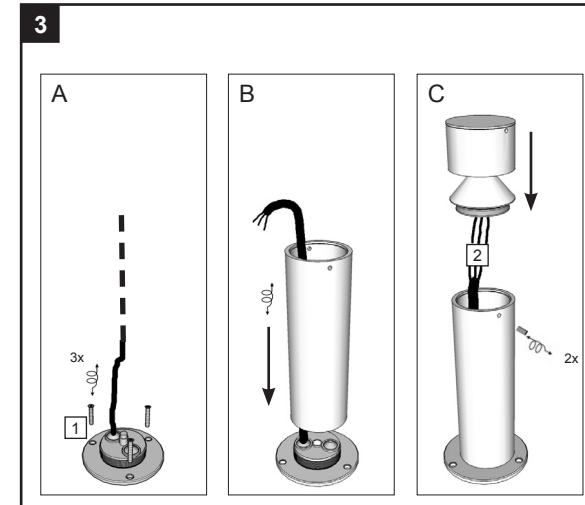
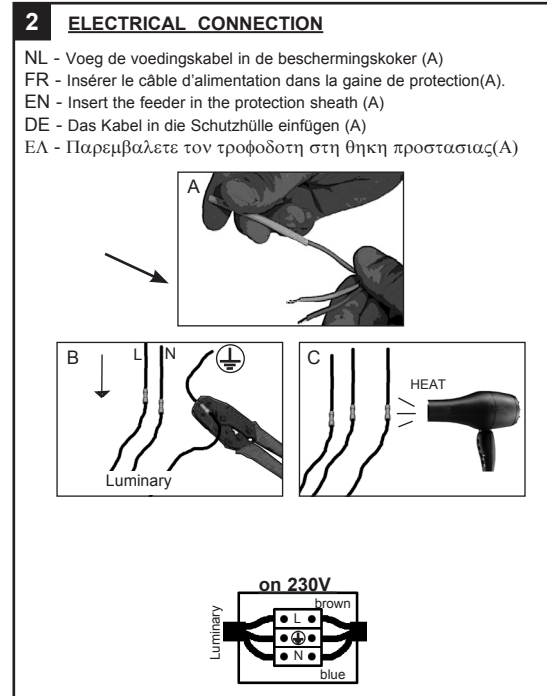
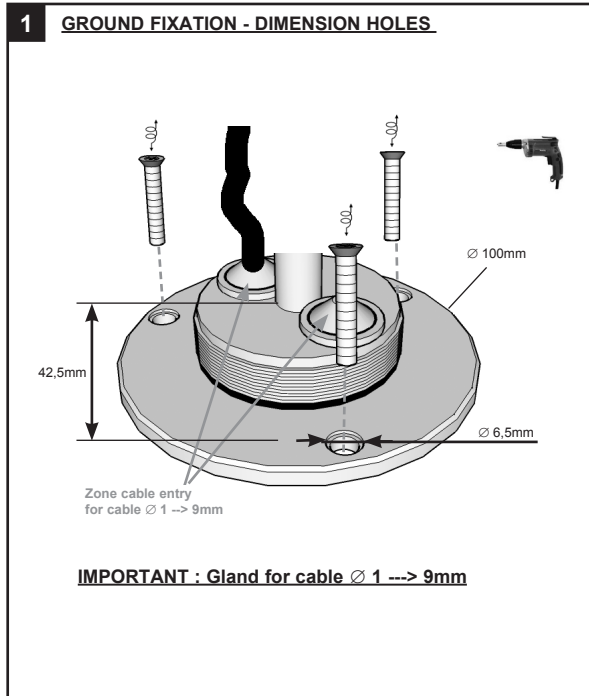

## belpasta 1g

NL Voor een correcte installatie is het verplicht de schroeven te behandelen met belpasta.  
FR Pour une bonne installation, vous devez enduire les parties à visser avec la graisse belpasta ci-jointe.  
EN For a good installation, it is obliged to put the grease belpasta on the screwing part.  
DE Sie müssen die Teile der Leuchte, die geschraubt werden mit dem beigefügten Fett belpasta bestreichen.  
GR Για καλυ εγκατασταση, σας συνιστούμε να βαλετε στα σημεια προσ βιδωμα λιγο γρασο belpasta, το οποιο βρισκεται στην συσκευασια.

## PART

### A

Lees de algemene gebruiksvoorwaarden : PART B  
Lire attentivement les conditions generales d'utilisation: PART B  
Read attentively the general instructions: PART B  
Lesen Sie die allgemeinen Gebrauchsanweisungen: PART B  
Διαβάστε της γενικες οδηγίες : PART B

WAARSCHUWING  
AVERTISSEMENT  
WARNING  
WARNUNG  
ΠΡΟΣΟΧΗ