



Vigo

last update 27/09/2015

BEL1006

Vigo :

code 1159_ 11.04

1,2W - 350mA - CE - IP65 -  -  - 



BEL LIGHTING sprl
Avenue Ernest Solvay 42
B-1480 Saintes (Tubize)
Belgium
Phone: +32(0)2 3552428
Fax: +32(0)2 3550396
e-mail: info@bel-lighting.com
www.bel-lighting.com

INSTALLATION INSTRUCTIONS - PART A

1. PREPARATION OF TERRAIN
2. MAKE THE ELECTRICAL CONNECTION
3. PLACE THE LUMINARY
4. FIXATION ON THE GROUND & PLACE THE COVERPLATE
5. SWITCH ON

1 NL - Voorbereiding op terreinwerk (uitholling en ontwatering)
FR - Préparation du terrain (trou et drainage)
EN - Preparation of terrain (troughs and drainage)
DE - Vorbereitung des Geländes (loch und drainage)
GR - Προετοιμασία του εδάφους (τρύπα και αποξήρανση)

**PVC house box: POP 3 (delivered separately)
Ref: X053**

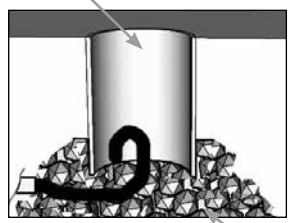

30cm

drainage

2 Use a junction box IP68

A Luminary

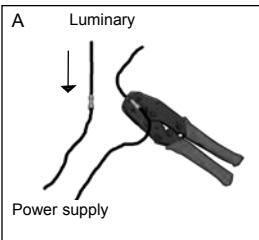

Power supply

B

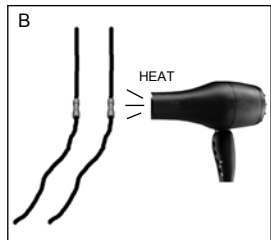

HEAT

Installation : Led Power Supply Red : +
Black: -

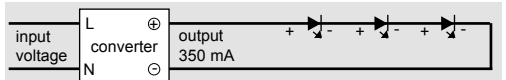

only use a Power supply delivery from BEL LIGHTING - SENICO

3

WARNING
Led: use dedicated
Power supply

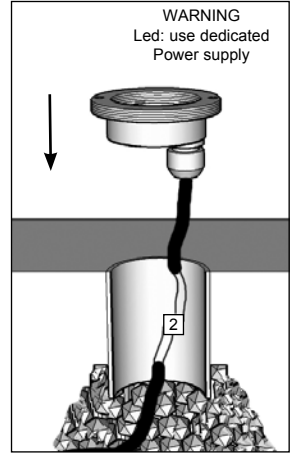

4

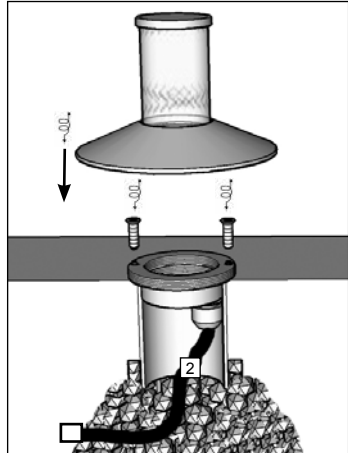

ACCESSORY SET (A)



2x

PART A

Lees de algemene gebruiksvoorwaarden : PART B
Lire attentivement les conditions générales d'utilisation: PART B
Read attentively the general instructions: PART B
Lesen Sie die allgemeinen Gebrauchsanweisungen: PART B
Διαβάστε της γενικές οδηγίες : PART B

WAARSCHUWING
AVERTISSEMENT
WARNING
WARNUNG
ΠΡΟΣΟΧΗ