



















Omega - Taf

last update 24/09/2015

BEL1049

BEL LIGHTING

BEL LIGHTING srl
Avenue Ernest Solvay 42
B-1480 Saintes (Tubize)
Belgium
Phone: +32(0)2 3552428
Fax: +32(0)2 3550396
e-mail: info@bel-lighting.com
www.bel-lighting.com

Omega 1:	code 910SA.G9. __	max.60W H-PIN/G9 - CE - IP65 (exterior) or IP40 (interior) -  -  - 0,5mm - 
Omega 1:	code 910SA.W6. __	LED 6W - 230V~ - CE - IP65 (exterior) or IP40 (interior) -  -  - 0,5mm - 
Omega 2:	code 913SA.G9. __	max.60W H-PIN/G9 - 230V~ - CE - IP65 (exterior) or IP40 (interior) -  -  - 0,5mm - 
Taf 1:	code 914SA.G9. __	max.60W H-PIN/G9 - CE - IP65 (exterior) or IP40 (interior) -  -  - 0,5mm - 
Taf 1:	code 914SA.W6. __	LED 6W - 230V~ - CE - IP65 (exterior) or IP40 (interior) -  -  - 0,5mm - 
Taf 2:	code 917SA.G9. __	max.60W H-PIN/G9 - 230V~ - CE - IP65 (exterior) or IP40 (interior) -  -  - 0,5mm - 

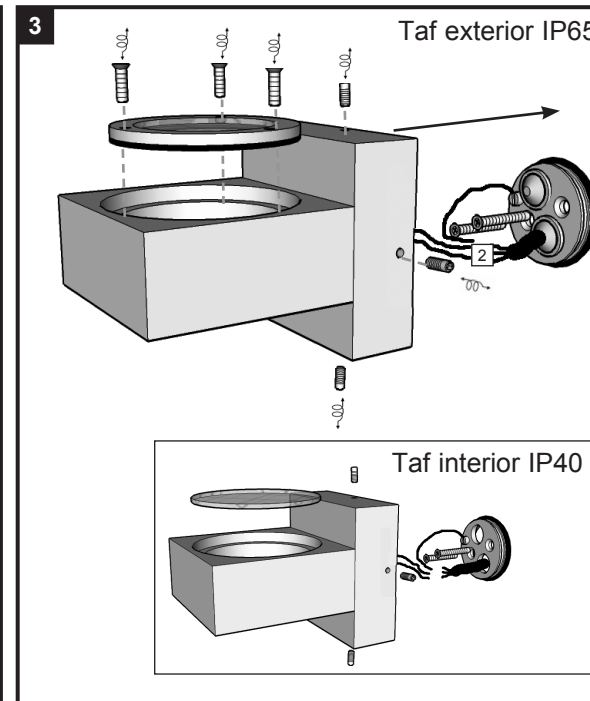
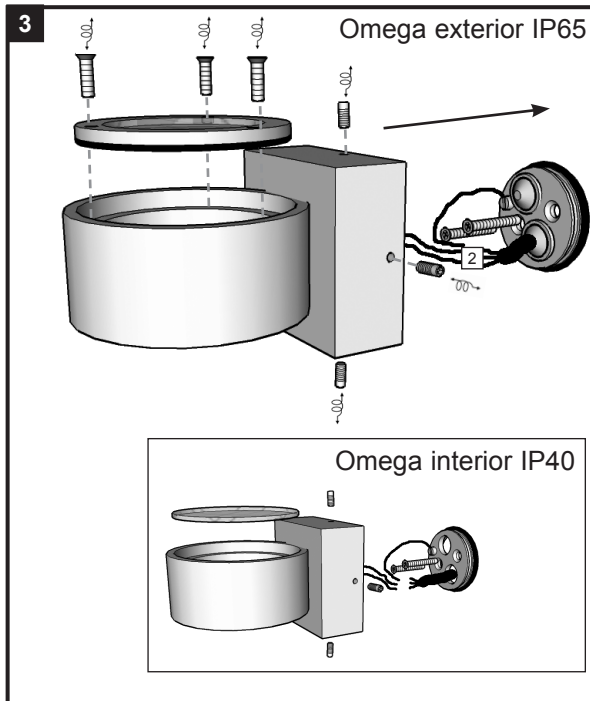
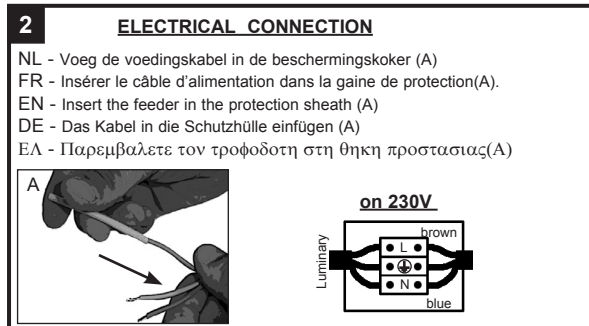
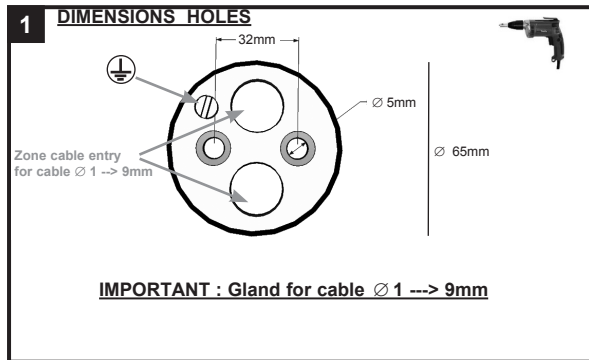

PART
A

Lees de algemene gebruiksvoorwaarden : PART B
Lire attentivement les conditions générales d'utilisation: PART B
Read attentively the general instructions: PART B
Lesen Sie die allgemeinen Gebrauchsanweisungen: PART B
Αναβάστε της γενικες οδηγίες : PART B

INSTALLATION INSTRUCTIONS - PART A

1. FIT THE WALL FIXATION ON THE WALL
2. MAKE THE ELECTRICAL CONNECTION
3. PLACE THE LUMINARY
4. SWITCH ON

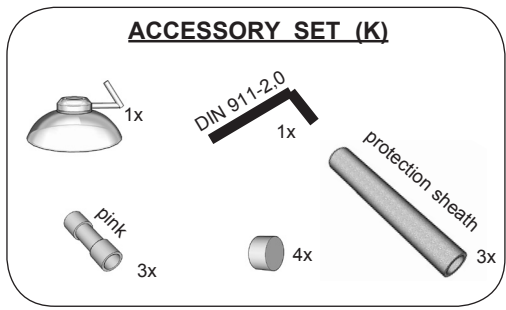

belpasta 1g
(for exterior lighting)

NL Voor een correcte installatie is het verplicht de schroeven te behandelen met belpasta.
FR Pour une bonne installation, vous devez enduire les parties à visser avec la graisse belpasta ci-jointe.
EN For a good installation, it is obliged to put the grease belpasta on the screwing part.
DE Sie müssen die Teile der Leuchte, die geschraubt werden mit dem beigegeführten Fett belpasta bestreichen.
GR Για καλή εγκατάσταση, σας συνιστούμε να βάλετε στα σημεία προς βίδωμα λίγο γρασο belpasta, το οποίο βρίσκεται στην συσκευασία.

WAARSCHUWING
AVERTISSEMENT
WARNING
WARNING
ΠΡΟΣΟΧΗ



















Omega IN - Taf IN

last update 24/09/2015

BEL1049

BEL LIGHTING

BEL LIGHTING sprl
Avenue Ernest Solvay 42
B-1480 Saintes (Tubize)
Belgium
Phone: +32(0)2 3552428
Fax: +32(0)2 3550396
e-mail: info@bel-lighting.com
www.bel-lighting.com

Omega 1 IN: code 911SA.G9. __	max.60W H-PIN/G9 - CE - IP44 (exterior) or IP40 (interior) -  -  - 0,5mm - 
Omega 1 IN: code 911SA.W6. __	LED 6W - 230V~ - CE - IP44 (exterior) or IP40 (interior) -  -  - 0,5mm - 
Omega 2 IN: code 912SA.G9. __	max.60W H-PIN/G9 - 230V~ - CE - IP44 (exterior) or IP40 (interior) -  -  - 0,5mm - 
Taf 1 IN: code 915SA.G9. __	max.60W H-PIN/G9 - CE - IP44 (exterior) or IP40 (interior) -  -  - 0,5mm - 
Taf 1 IN: code 915SA.W6. __	LED 6W - 230V~ - CE - IP44 (exterior) or IP40 (interior) -  -  - 0,5mm - 
Taf 2 IN: code 916SA.G9. __	max.60W H-PIN/G9 - 230V~ - CE - IP44 (exterior) or IP40 (interior) -  -  - 0,5mm - 

INSTALLATION INSTRUCTIONS - PART A

1. FIT THE PVC HOUSE BOX IN THE WALL
2. MAKE THE ELECTRICAL CONNECTION
3. PLACE THE LUMINARY
4. SWITCH ON

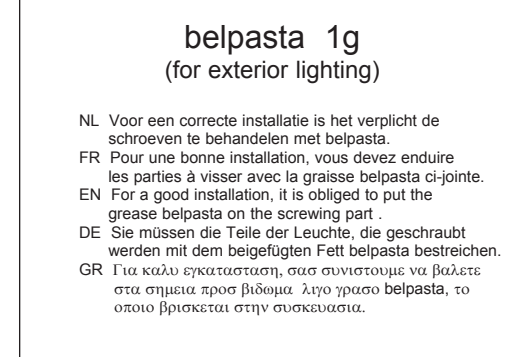
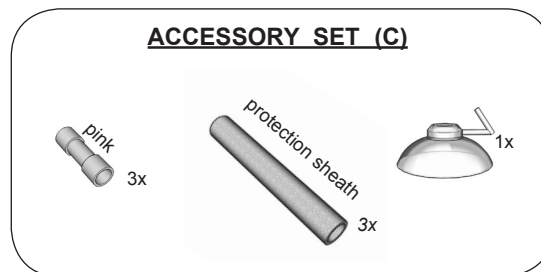
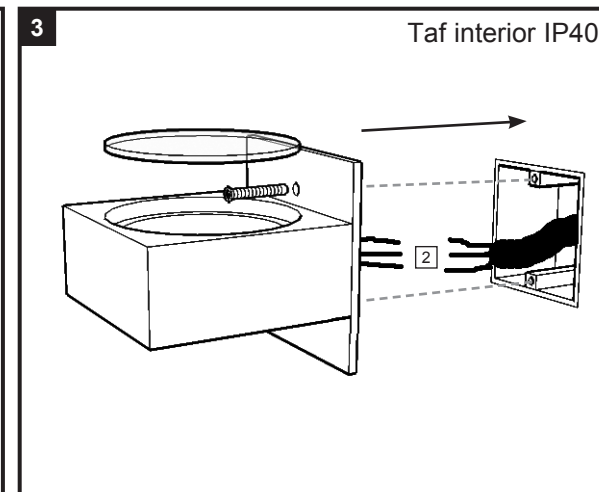
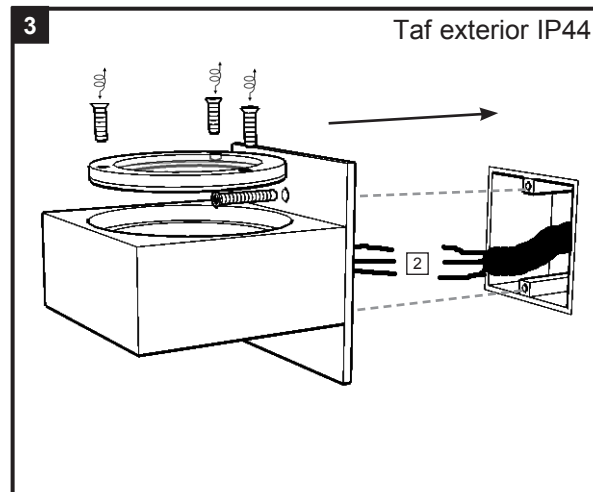
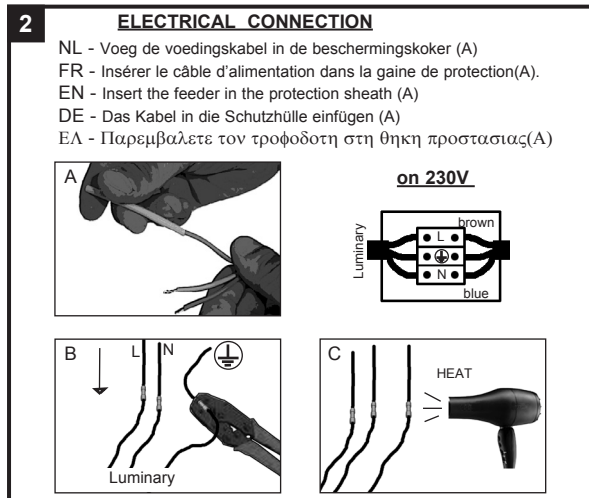
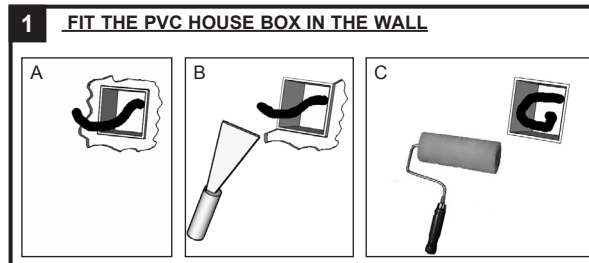

PART A

Lees de algemene gebruiksvaardigheden : PART B
Lire attentivement les conditions générales d'utilisation: PART B
Read attentively the general instructions: PART B
Lesen Sie die allgemeinen Gebrauchsanweisungen: PART B
Διαβάστε τις γενικές οδηγίες : PART B

WAARSCHUWING
AVERTISSEMENT
WARNING
WARNING
ΠΡΟΣΟΧΗ