





last update 31/03/2020

CUBE (exterior)

BEL1046

Cube TR:	code 906.GU.__	GU10 LED (max. height 52mm) - 220/240V	
Cube 1L:	code 902.GU.__	GU10 LED (max. height 52mm) - 220/240V	
Cube 2L:	code 902.GU.__	GU10 LED (max. height 52mm) - 220/240V	
Cube Bis:	code 902.GU.__	GU10 LED (max. height 52mm) - 220/240V	







 - IP65 - IK04

IP65

Volledig stofdicht - Beschermd tegen waterstralen uit alle richtingen
 Etanche aux poussières - Protégé contre les jets d'eau de toutes directions
 Staubdicht - Schutz vor Strahlwasser
 Fully tight - Protected against water jets
 Απόλυτη προστασία από τη σκόνη - Προστασία από πίεση νερού από όλες τις κατευθύνσεις



Correcte verwijdering van dit product (Elektrische&elektronische afvalapparatuur)
 Comment éliminer ce produit (Déchets d'équipements électriques&électroniques)
 Korrekte Entsorgung dieses Produkts (Elektromüll)
 Correct disposal of this product (Waste electrical&electrical equipment)
 Τρόπος απόρριψης αυτού του προϊόντος (Απορρίμματα Ηλεκτρικού & Ηλεκτρονικού Εξοπλισμού)



BEL LIGHTING srl
 Avenue Ernest Solvay 42
 B-1480 Saintes (Tubize)
 Belgium
 Phone: +32(0)2 3552428
 Fax: +32(0)2 3550396
 e-mail: info@bel-lighting.com
 www.bel-lighting.com

PART

A

Lees de algemene gebruiksvoorwaarden : PART B
 Lire attentivement les conditions générales d'utilisation: PART B
 Read attentively the general instructions: PART B
 Lesen Sie die allgemeinen Gebrauchsanweisungen: PART B
 Διαβάστε της γενικές οδηγίες : PART B

WAARSCHUWING
 AVERTISSEMENT
 WARNING
 WARNUNG
 ΠΡΟΣΟΧΗ

ATTENTION - WARNING

Le luminaire doit être installé et connecté par un technicien qualifié.
 The luminaire should be installed and connected by a qualified technician.

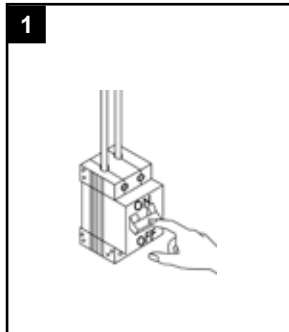

INSTALLATION INSTRUCTIONS - PART A

- Before accessing any parts carrying live voltage, the power must be disconnected
Avant tout accès à des parties sous tension, la tension doit être coupée
- Place the luminaire
Placer le luminaire
- Make the electrical connection
Faire la connexion électrique
- Switch on
Allumer

Cube 1L

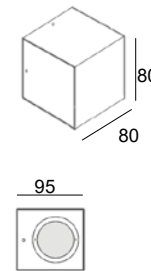

Cube TR

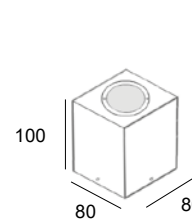

Cube 2L

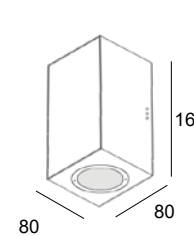

Cube Bis

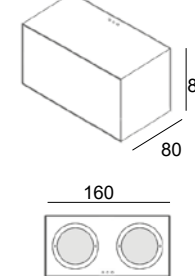

2 FIXATION - DIMENSION HOLES

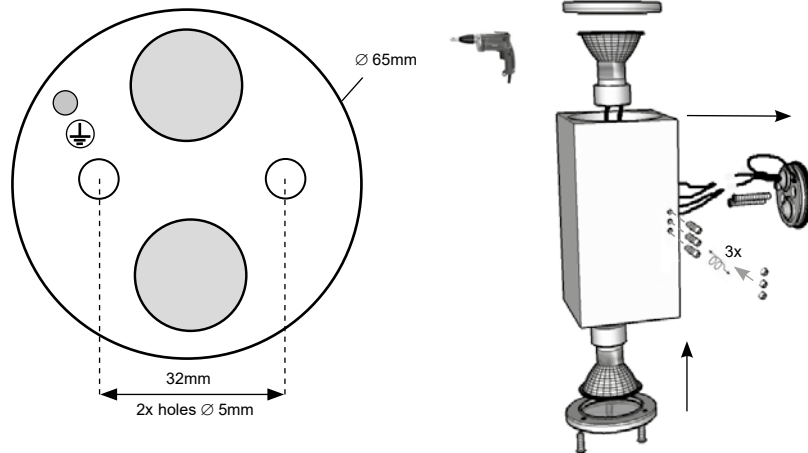

2x cable gland for cable diameter maximum 9mm

3 ELECTRICAL CONNECTION

NL - Voeg de voedingskabel in de beschermingskoker (A)
 FR - Insérer le câble d'alimentation dans la gaine de protection(A).
 EN - Insert the feeder in the protection sheath (A)
 DE - Das Kabel in die Schutzhülle einfügen (A)
 EL - Παρεμβάλετε τον τροφοδοτή στη θηκή προστασίας(A)

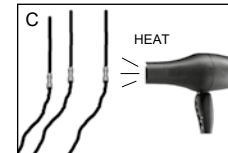
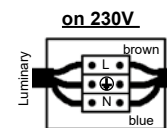
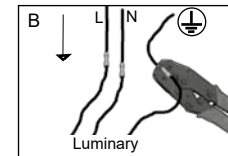

ACCESSORY SET (K)

